

Access Soft Seating

276x with Left Arm

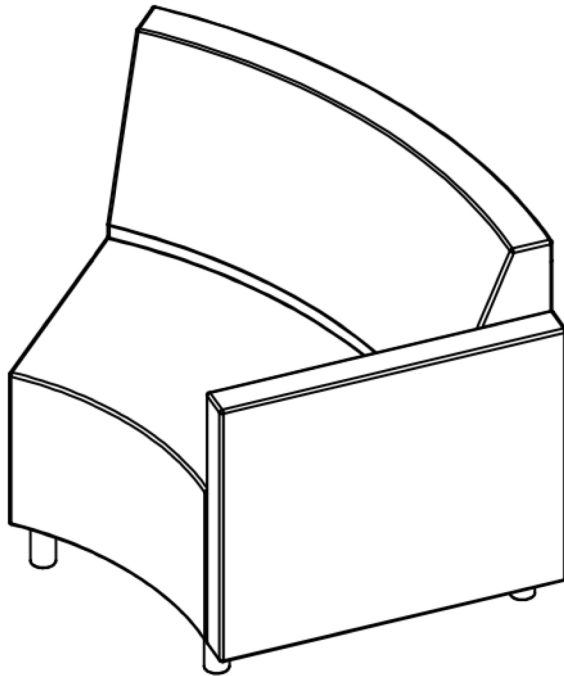

Overview

Frame Construction:
3/4" CDX Grade Engineered Frames
Hardwood Blocks
Glued and Mechanically fastened frames

Suspensions for seats and backs.
Legget and Platt Matrex System Webbing for long lasting comfort

Foam Specifications:
Seat Foams 2.4 minimum Density HR rated - 40 ILD (Inner Lineal Deflection)
Back Foams 1.8 minimum Density HR rated - 34 ILD (Inner Lineal Deflection)
All Foams meet TB 117
All Foams and Suspensions designed for long life and comfort

Sewing Specifications:
Highest Quality Tri-Star 16oz Thread Used
Top Stitch details with full 1/2" seams (double-sewn)

Fabrics offered: Momentum, Culp, Spradling, and Mayers

