

Access Soft Seating

274x with Right Arm

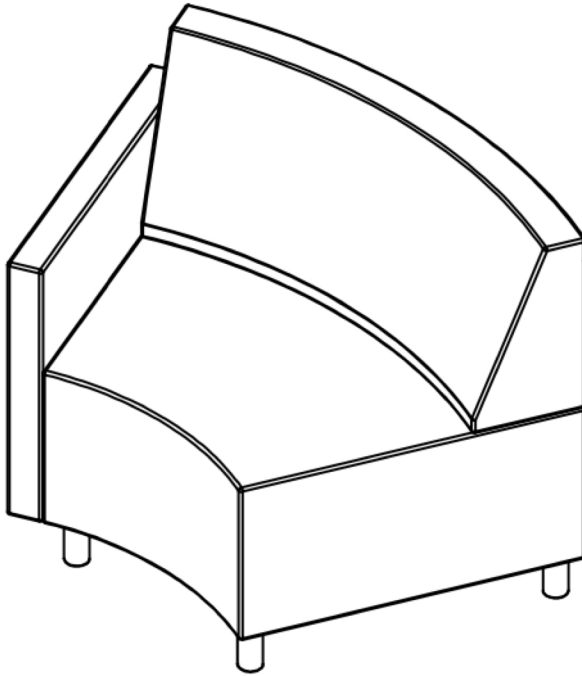

Overview

Frame Construction:

3/4" CDX Grade Engineered Frames

Hardwood Blocks

Glued and Mechanically fastened frames

Suspensions for seats and backs.

Legget and Platt Matrex System Webbing for long lasting comfort

Foam Specifications:

Seat Foams 2.4 minimum Density HR rated - 40 ILD (Inner Lineal Deflection)

Back Foams 1.8 minimum Density HR rated - 34 ILD (Inner Lineal Deflection)

All Foams meet TB 117

All Foams and Suspensions designed for long life and comfort

Sewing Specifications:

Highest Quality Tri-Star 16oz Thread Used

Top Stitch details with full 1/2" seams (double-sewn)

Fabrics offered: Momentum, Culp, Spradling, and Mayers

